

CE

**CE-EMC
TEST REPORT**

Client Name : Guangdong Ankuai Intelligent Technology Co., Ltd.

Address : Ankuai Science And Technology Park, No.106, Tangxia Section,
Tangtian South Road, Tangxia Town, Dongguan City, Guangdong
Province, China.

Product Name : Barrier Gate

Test Model No. : AK47

Report No. : CCTI-2022071909E

Issued Date : Jul. 29, 2022

Prepared By : Shenzhen CCTI Technology Co., Ltd.

Address : 7th Floor, Block A, Building E, Yongwei Industrial Park, No. 118,
Yongfu Road, Qiaotou, Fuhai Street, Bao'an District, Shenzhen,
Guangdong, China

Contact Info : Tel : 0086-400-188-9662 E-mail : ccti@ccti-lab.com
Fax : 0086-755-2722 5865 W e b : www.ccti-lab.com

TEST REPORT VERIFICATION

Applicant : Guangdong Ankuai Intelligent Technology Co., Ltd.
Address : Ankuai Science And Technology Park, No.106, Tangxia Section, Tangtian South Road, Tangxia Town, Dongguan City, Guangdong Province, China.
Manufacturer : Guangdong Ankuai Intelligent Technology Co., Ltd.
Address : Ankuai Science And Technology Park, No.106, Tangxia Section, Tangtian South Road, Tangxia Town, Dongguan City, Guangdong Province, China.
Product Name : Barrier Gate
Model No. : AK47
Series No. : AKD158,AKD116,AKD115C,AKD117,AKD906,AKD908,AKD102C,AKD209,AKD206,AKD207KBII,AKS580,AK48,AK49,AKD168,AKD118,AKD166,AKD188,AKD186,AKD126
Trade Mark : N/A
Rating(s) : Input: 24Vdc, 100W, Class III
Test Date : Jul. 15, 2022 to Jul. 29, 2022
Test Standard(s) : EN IEC 55014-1:2021
EN IEC 61000-3-2:2019+A1:2021
EN 61000-3-3:2013+A2:2021+AC:2022-01
EN IEC 55014-2:2021

Test Result : PASS

This device described above has been tested by CCTI, and the test results show that the equipment under test (EUT) is in compliance with the EMC Directive 2014/30/EU requirements. The results shown in this test report refer only to the sample(s) tested unless other wise stated and the sample(s) are retained for 30 days only.

The document is issued by CCTI, may be altered or revised by CCTI, personal only, and shall be noted in the revision of the document. this document cannot be reproduced except in full with our prior written permission.

Producer By : Jason Wang Date : Jul. 29, 2022
(Betty Liang / Engineer)

Authorized Signer : Corey Mao Date : Jul. 29, 2022
(Corey Mao / Manager)



TABLE OF CONTENTS

1. GENERAL INFORMATION.....	5
1.1. Description of Device (EUT).....	5
1.2. Test Facility.....	5
1.3. Tested System Details.....	5
1.4. Test Uncertainty.....	5
2. TEST INSTRUMENT USED.....	6
3. CONDUCTED EMISSION AT THE MAINS TERMINALS TEST.....	9
3.1. Block Diagram Of Test Setup.....	9
3.2. Test Standard.....	9
3.3. Power Line Conducted Emission Limit.....	9
3.4. EUT Configuration on Test.....	9
3.5. Operating Condition of EUT.....	9
3.6. Test Procedure.....	10
3.7. Test Result.....	10
4. DISTURBANCE POWER TEST.....	13
4.1. Block Diagram of Test Setup.....	13
4.2. Test Standard.....	13
4.3. Disturbance Power Limit.....	13
4.4. EUT Configuration on Test.....	13
4.5. Operating Condition of EUT.....	13
4.6. Test Procedure.....	14
4.7. Test Result.....	14
5. HARMONIC CURRENT EMISSION TEST.....	16
5.1. Block Diagram of Test Setup.....	16
5.2. Test Standard.....	16
5.3. Operating Condition of EUT.....	16
5.4. Test Procedure.....	16
5.5. Test Results.....	16
6. VOLTAGE FLUCTUATIONS & FLICKER TEST.....	17
6.1. Block Diagram of Test Setup.....	17
6.2. Test Standard.....	17
6.3. Operating Condition of EUT.....	17
6.4. Test Procedure.....	17
6.5. Test Results.....	17
7. ELECTROSTATIC DISCHARGE IMMUNITY TEST.....	18
7.1. Block Diagram of Test Setup.....	18
7.2. Test Standard.....	18
7.3. Severity Levels and Performance Criterion.....	18
7.4. EUT Configuration.....	19
7.5. Operating Condition of EUT.....	19
7.6. Test Procedure.....	19
7.7. Test Results.....	20
8. RF FIELD STRENGTH SUSCEPTIBILITY TEST.....	21
8.1. Block Diagram of Test Setup.....	21
8.2. Test Standard.....	21
8.3. Severity Levels and Performance Criterion.....	21
8.4. EUT Configuration on Test.....	22
8.5. Operating Condition of EUT.....	22
8.6. Test Procedure.....	22

8.7. Test Results.....	23
9. ELECTRICAL FAST TRANSIENT/BURST IMMUNITY TEST.....	24
9.1. Block Diagram of EUT Test Setup.....	24
9.2. Test Standard.....	24
9.3. Severity Levels and Performance Criterion.....	24
9.4. EUT Configuration on Test.....	25
9.5. Operating Condition of EUT.....	25
9.6. Test Procedure.....	25
9.7. Test Results.....	25
10. SURGE TEST.....	26
10.1. Block Diagram of EUT Test Setup.....	26
10.2. Test Standard.....	26
10.3. Severity Levels and Performance Criterion.....	26
10.4. EUT Configuration on Test.....	27
10.5. Operating Condition of EUT.....	27
10.6. Test Procedure.....	27
10.7. Test Result.....	27
11. INJECTED CURRENTS SUSCEPTIBILITY TEST.....	28
11.1. Block Diagram of EUT Test Setup.....	28
11.2. Test Standard.....	28
11.3. Severity Levels and Performance Criterion.....	28
11.4. EUT Configuration on Test.....	29
11.5. Operating Condition of EUT.....	29
11.6. Test Procedure.....	29
11.7. Test Result.....	29
12. MAGNETIC FIELD IMMUNITY TEST.....	30
12.1. Block Diagram of Test Setup.....	30
12.2. Test Standard.....	30
12.3. Severity Levels and Performance Criterion.....	30
12.4. EUT Configuration on Test.....	31
12.5. Operating Condition of EUT.....	31
12.6. Test Procedure.....	31
12.7. Test Results.....	31
13. VOLTAGE DIPS AND INTERRUPTIONS TEST.....	32
13.1. Block Diagram of EUT Test Setup.....	32
13.2. Test Standard.....	32
13.3. Severity Levels and Performance Criterion.....	32
13.4. EUT Configuration on Test.....	33
13.5. Operating Condition of EUT.....	33
13.6. Test Procedure.....	33
13.7. Test Result.....	33
APPENDIX I -- EUT PHOTOGRAPHS.....	34
APPENDIX II -- EUT TEST PHOTOGRAPHS.....	39

1. GENERAL INFORMATION

1.1. Description of Device (EUT)

EUT : Barrier Gate

Trademark : N/A

Model Number : AK47

Serial Model : AKD158,AKD116,AKD115C,AKD117,AKD906,AKD908,AKD102C,AKD209,AKD206,AKD207KBII,AKS580,AK48,AK49,AKD168,AKD118,AKD166,AKD188,AKD186,AKD126

Model Difference : The product is different for model number and power.

Power Supply : Input: 24Vdc, 100W, Class III

Remark:

(1) AK47 was selected as the test model and the datas have been recorded in this report.

(2) For a more detailed features description, please refer to the manufacturer's specifications or the User's Manual.

1.2. Test Facility

Shenzhen CCTI Technology Co., Ltd.

7th Floor, Block A, Building E, Yongwei Industrial Park, No. 118, Yongfu Road, Qiaotou, Fuhai Street, Bao'an District, Shenzhen, Guangdong, China

1.3. Tested System Details

None.

1.4. Test Uncertainty

Conducted Emission Uncertainty : $\pm 2.66\text{dB}$

Radiated Emission Uncertainty : $\pm 4.26\text{dB}$

2. TEST INSTRUMENT USED

2.1. For Conducted Emission at the mains terminals Test

Conducted Emission Test (A --- site)					
Equipment	Manufacturer	Model#	Serial#	Last Cal.	Next Cal.
843 Shielded Room	ChengYu	843 Room	843	Mar. 09, 2022	Mar. 08, 2023
EMI Receiver	R&S	ESCI	101421	Mar. 09, 2022	Mar. 08, 2023
LISN	Schwarzbeck	NSLK8127	8127739	Mar. 09, 2022	Mar. 08, 2023
Attenuator	R&S	ESH3-Z2	CCTI021E	Mar. 09, 2022	Mar. 08, 2023
843 Cable 1#	FUJIKURA	843C1#	001	Mar. 09, 2022	Mar. 08, 2023

2.2. For Conducted Emission at the telecom port Test

Conducted Emission Test (A --- site)					
Equipment	Manufacturer	Model#	Serial#	Last Cal.	Next Cal.
843 Shielded Room	ChengYu	843 Room	843	Mar. 09, 2022	Mar. 08, 2023
EMI Receiver	R&S	ESCI	101421	Mar. 09, 2022	Mar. 08, 2023
Coupling/ Decoupling Network	PH	ISN T800	S1509001	Mar. 09, 2022	Mar. 08, 2023
Attenuator	R&S	ESH3-Z2	CCTI021E	Mar. 09, 2022	Mar. 08, 2023
843 Cable 1#	FUJIKURA	843C1#	001	Mar. 09, 2022	Mar. 08, 2023

2.3. For Radiated Emission Test

Radiation Emission Test (966 chamber)					
Equipment	Manufacturer	Model#	Serial#	Last Cal.	Next Cal.
966 chamber	ChengYu	966 Room	966	Mar. 09, 2022	Mar. 08, 2023
Spectrum Analyzer	Agilent	E4407B	MY45109572	Mar. 09, 2022	Mar. 08, 2023
Amplifier	Schwarzbeck	BBV9743	9743-119	Mar. 09, 2022	Mar. 08, 2023
Amplifier	Schwarzbeck	BBV9718	9718-270	Mar. 09, 2022	Mar. 08, 2023
Log-periodic Antenna	Schwarzbeck	VULB9160	VULB9160-3369	Mar. 09, 2022	Mar. 08, 2023
EMI Receiver	R&S	ESCI	101421	Mar. 09, 2022	Mar. 08, 2023
Horn Antenna	Schwarzbeck	BBHA9120D	9120D-1275	Mar. 09, 2022	Mar. 08, 2023
966 Cable 1#	CHENGYU	966	004	Mar. 09, 2022	Mar. 08, 2023
966 Cable 2#	CHENGYU	966	003	Mar. 09, 2022	Mar. 08, 2023

2.4. For Harmonic & Flicker Test

Harmonic / Flicker Test (A --- site)					
Equipment	Manufacturer	Model#	Serial#	Last Cal.	Next Cal.
Harmonic / Flicker Analyzer	KIKUSUI	KHA1000	VA002445	Mar. 09, 2022	Mar. 08, 2023
AC Power Supply	KIKUSUI	PCR4000M	UK001879	Mar. 09, 2022	Mar. 08, 2023
Line Impedance network	KIKUSUI	LIN1020JF	UL001611	Mar. 09, 2022	Mar. 08, 2023

2.5. For Electrostatic Discharge Immunity Test

For Electrostatic Discharge Immunity Test (A --- site)					
Equipment	Manufacturer	Model#	Serial#	Last Cal.	Next Cal.
ESD Tester	KIKUSUI	KES4201A	UH002321	Mar. 09, 2022	Mar. 08, 2023

2.6. For RF Field Strength Susceptibility Test (SMQ)

RF Field Strength Susceptibility Test (SMQ --- site)					
Equipment	Manufacturer	Model#	Serial#	Last Cal.	Next Cal.
Signal Generator	HP	8648A	3625U00573	Mar. 09, 2022	Mar. 08, 2023
Amplifier	A&R	500A100	17034	Mar. 09, 2022	Mar. 08, 2023
Amplifier	A&R	100W/1000M1	17028	Mar. 09, 2022	Mar. 08, 2023
Audio Analyzer (20Hz~1GHz)	Panasonic	2023B	202301/428	Mar. 09, 2022	Mar. 08, 2023
Isotropic Field Probe	A&R	FP2000	16755	Mar. 09, 2022	Mar. 08, 2023
Antenna	EMCO	3108	9507-2534	Mar. 09, 2022	Mar. 08, 2023
Log-periodic Antenna	A&R	AT1080	16812	Mar. 09, 2022	Mar. 08, 2023

2.7. For Electrical Fast Transient /Burst Immunity Test

Electrical Fast Transient/Burst Immunity Test (A --- site)					
Equipment	Manufacturer	Model#	Serial#	Last Cal.	Next Cal.
Burst Tester	Prima	EFT61004AG	PR14054467	Mar. 09, 2022	Mar. 08, 2023
Coupling Clamp	Prima	EFT61004AG	CCTI009E	Mar. 09, 2022	Mar. 08, 2023

2.8. For Surge Test

For Surge Test (A --- site)					
Equipment	Manufacturer	Model#	Serial#	Last Cal.	Next Cal.
Surge Tester	Prima	SUG61005BX	PR12045446	Mar. 09, 2022	Mar. 08, 2023

2.9. For Injected Currents Susceptibility Test

For Injected Currents Susceptibility Test (A --- site)					
Equipment	Manufacturer	Model#	Serial#	Last Cal.	Next Cal.
C/S Test System	SCHLODER	CDG600	126B1281	Mar. 09, 2022	Mar. 08, 2023
CDN	SCHLODER	CDN-M2+3	A2210320/2015	Mar. 09, 2022	Mar. 08, 2023
Injection Clamp	SCHLOBER	EMCL-20	132A1214/2015	Mar. 09, 2022	Mar. 08, 2023

2.10. For Magnetic Field Immunity Test

For Magnetic Field Immunity Test (A --- site)					
Equipment	Manufacturer	Model#	Serial#	Last Cal.	Next Cal.
Magnetic field generator	HTEC	HPFMF	15701	Mar. 09, 2022	Mar. 08, 2023

2.11. For Voltage Dips Interruptions Test

For Voltage Dips Interruptions Test (A --- site)					
Equipment	Manufacturer	Model#	Serial#	Last Cal.	Next Cal.
Dips Tester	Prima	DRP61011AG	PR14086284	Mar. 09, 2022	Mar. 08, 2023

3. CONDUCTED EMISSION AT THE MAINS TERMINALS TEST

3.1. Block Diagram Of Test Setup

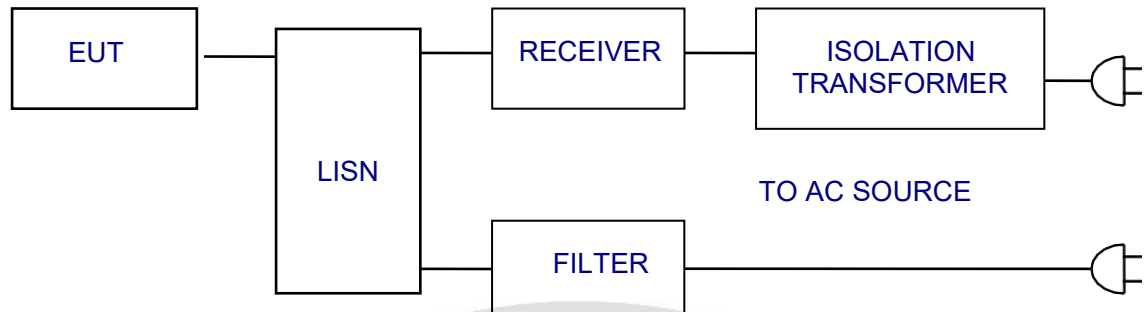

3.2. Test Standard

EN IEC 55014-1:2021

3.3. Power Line Conducted Emission Limit

Frequency MHz	Limits dB(μ V)	
	Quasi-peak Level	Average Level
0.15 ~ 0.50	66 ~ 56*	56 ~ 46*
0.50 ~ 5.00	56	46
5.00 ~ 30.00	60	50

Notes: 1. *Decreasing linearly with logarithm of frequency.
 2. The lower limit shall apply at the transition frequencies.

3.4. EUT Configuration on Test

The following equipment are installed on conducted emission test to meet EN 55014 requirement and operating in a manner which tends to maximize its emission characteristics in a normal application.

3.5. Operating Condition of EUT

- 3.5.1. Setup the EUT and simulators as shown in Section 3.1.
- 3.5.2. Turn on the power of all equipment.
- 3.5.3. Let the EUT work in test modes and test it.

3.6. Test Procedure

The EUT is put on the ground and connected to the AC mains through a Artificial Mains Network (AMN). This provided a 50ohm coupling impedance for the tested equipment. Both sides of AC line are checked to find out the maximum conducted emission levels according to the EN 55014 regulations during conducted emission test.

The bandwidth of the test receiver (R&S Test Receiver ESCI) is set at 10KHz.

The frequency range from 150 KHz to 30 MHz is investigated.

3.7. Test Result

PASS

Please refer to the following page.



Conducted Emission At The Mains Terminals Test Data			
Temperature:	24.5 °C	Relative Humidity:	54%
Pressure:	1009hPa	Phase :	Line
Test Voltage :	DC 24V From Adapter Input AC 230V/50Hz	Test Mode:	Working

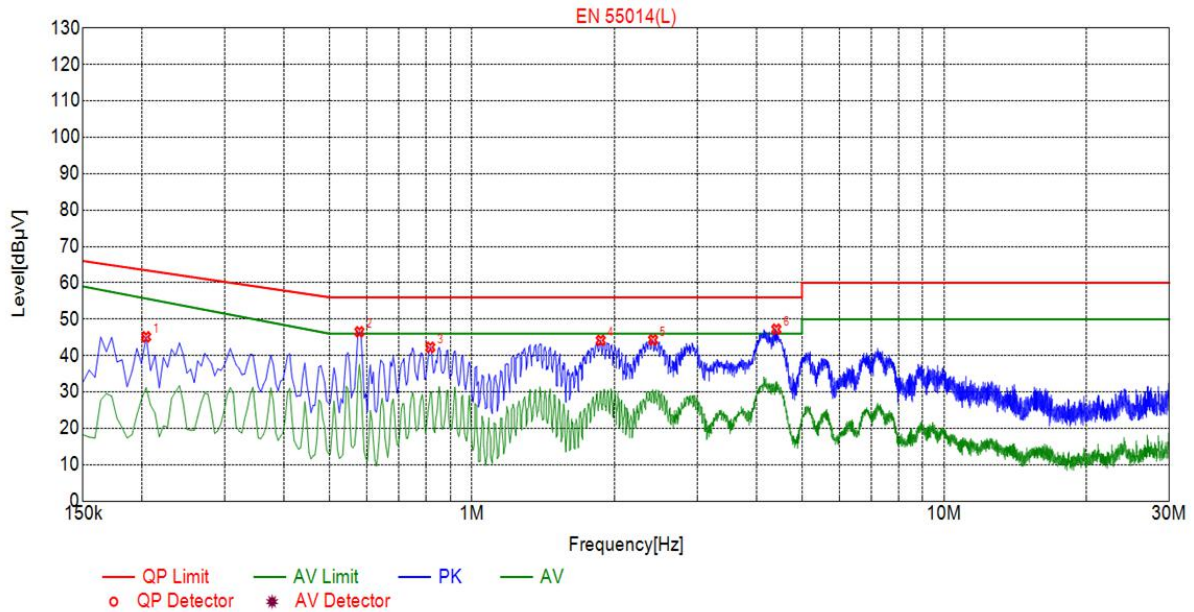

Suspected List

NO.	Freq. [MHz]	Level [dBµV]	Factor [dB]	Limit [dBµV]	Margin [dB]	Reading [dBµV]	Detector	Type
1	0.2040	45.16	20.04	63.45	18.29	25.12	PK	L
2	0.5775	46.54	20.05	56.00	9.46	26.49	PK	L
3	0.8160	42.28	20.06	56.00	13.72	22.22	PK	L
4	1.8735	44.19	20.14	56.00	11.81	24.05	PK	L
5	2.4180	44.32	20.18	56.00	11.68	24.14	PK	L
6	4.4115	47.25	20.25	56.00	8.75	27.00	PK	L

Conducted Emission At The Mains Terminals Test Data

Temperature:	24.5 °C	Relative Humidity:	54%
Pressure:	1009hPa	Phase :	Neutral
Test Voltage :	DC 24V From Adapter Input AC 230V/50Hz	Test Mode:	Working

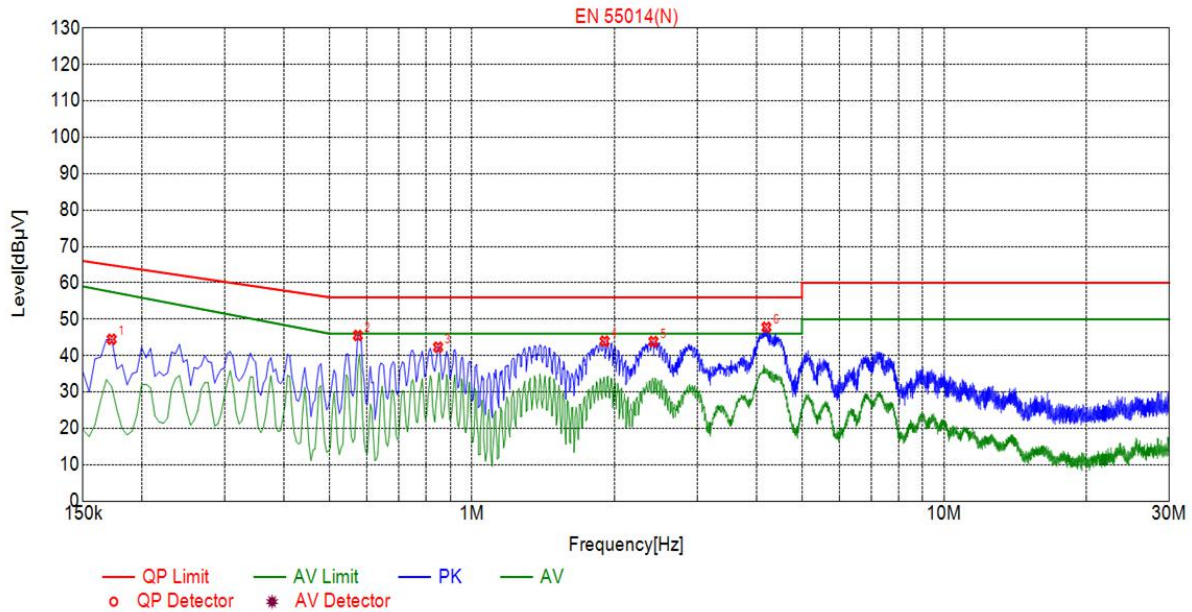

Suspected List

NO.	Freq. [MHz]	Level [dBμV]	Factor [dB]	Limit [dBμV]	Margin [dB]	Reading [dBμV]	Detector	Type
1	0.1725	44.49	20.04	64.84	20.35	24.45	PK	N
2	0.5730	45.54	20.05	56.00	10.46	25.49	PK	N
3	0.8475	42.31	20.06	56.00	13.69	22.25	PK	N
4	1.9095	43.96	20.14	56.00	12.04	23.82	PK	N
5	2.4225	43.85	20.18	56.00	12.15	23.67	PK	N
6	4.2045	47.78	20.25	56.00	8.22	27.53	PK	N

4. DISTURBANCE POWER TEST

4.1. Block Diagram of Test Setup

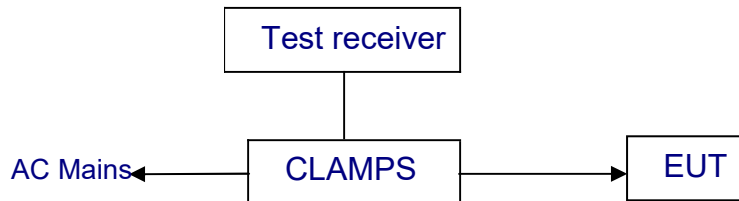

4.2. Test Standard

EN IEC 55014-1:2021

4.3. Disturbance Power Limit

Frequency MHz	Interference Power Limits dB(pW)	
	Quasi-peak Value	Average Value
30 ~ 300	45 ~55	35 ~ 45
Increasing linearly with the frequency.		

All emanations from devices or system including any network of conductors and apparatus connected thereto, shall not exceed the level of field strengths specified below:

4.4. EUT Configuration on Test

The following equipment are installed on conducted emission test to meet EN 55014-1 requirement and operating in a manner which tends to maximize its emission characteristics in a normal application.

4.5. Operating Condition of EUT

- 4.5.1. Setup the EUT and simulators as shown in Section 4.1.
- 4.5.2. Turn on the power of all equipment.
- 4.5.3. Let the EUT work in test modes and test it.

4.6. Test Procedure

The EUT is placed on the ground and away from other metallic surface at least 0.4m. It is connected to the power mains through an extension cord of 6m. The absorber clamp clamps the cord and moves from the far end to the EUT to measure the disturbing energy emitted from the cord.

The bandwidth of the test receiver (R&S Test Receiver ESCI) is set at 120KHz.

The frequency range from 30 MHz to 300 MHz is investigated.

4.7. Test Result

PASS

Please refer to the following page.



Disturbance Power Test Data			
Model :	AK47	Relative Humidity:	54%
Temperature:	24.5 °C	Pressure:	1009hPa
Test Voltage :	DC 24V From Adapter Input AC 230V/50Hz	Test Mode:	Working Mode

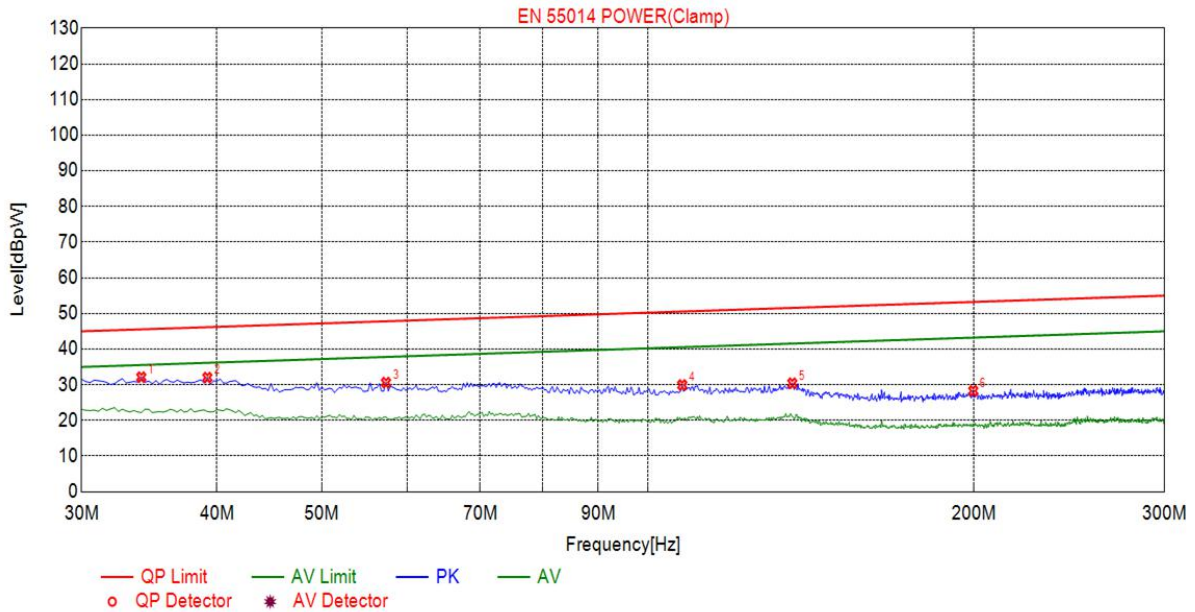

Suspected List								
NO.	Freq. [MHz]	Level[dBpW]	Factor [dB]	Reading [dBpW]	Limit [dBpW]	Margin [dB]	Detector	Type
1	34.0541	32.14	7.58	24.56	45.55	13.41	PK	Clamp
2	39.1892	32.04	7.76	24.28	46.16	14.12	PK	Clamp
3	57.2973	30.63	5.56	25.07	47.81	17.18	PK	Clamp
4	107.5676	29.95	5.06	24.89	50.55	20.60	PK	Clamp
5	135.9459	30.44	5.66	24.78	51.56	21.12	PK	Clamp
6	199.7297	28.29	3.09	25.20	53.23	24.94	PK	Clamp

5. HARMONIC CURRENT EMISSION TEST

5.1. Block Diagram of Test Setup

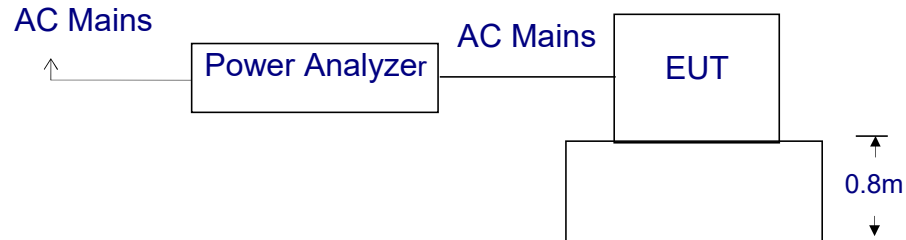

5.2. Test Standard

EN IEC 61000-3-2:2019+A1:2021

5.3. Operating Condition of EUT

- 5.3.1. Setup the EUT as shown in Section 5.1.
- 5.3.2. Turn on the power of all equipment.
- 5.3.3. Let the EUT work in test mode and test it.

5.4. Test Procedure

The power cord of the EUT is connected to the output of the test system. Turn on the power of the EUT and use the test system to test the harmonic current level.

5.5. Test Results

The EUT is powered by the DC only, the test item is not applicable.

6. VOLTAGE FLUCTUATIONS & FLICKER TEST

6.1. Block Diagram of Test Setup

Same as Section 5.1..

6.2. Test Standard

EN 61000-3-3:2013+A2:2021+AC:2022-01

6.3. Operating Condition of EUT

Same as Section 5.3.. The power cord of the EUT is connected to the output of the test system. Turn on the power of the EUT and use the test system to test the harmonic current level.

Flicker Test Limit

Test items	Limits
Pst	1.0
dc	3.3%
dmax	4.0%
dt	Not exceed 3.3% for 500ms

6.4. Test Procedure

The power cord of the EUT is connected to the output of the test system. Turn on the power of the EUT and use the test system to test the harmonic current level.

6.5. Test Results

The EUT is powered by the DC only, the test item is not applicable.

7. ELECTROSTATIC DISCHARGE IMMUNITY TEST

7.1. Block Diagram of Test Setup

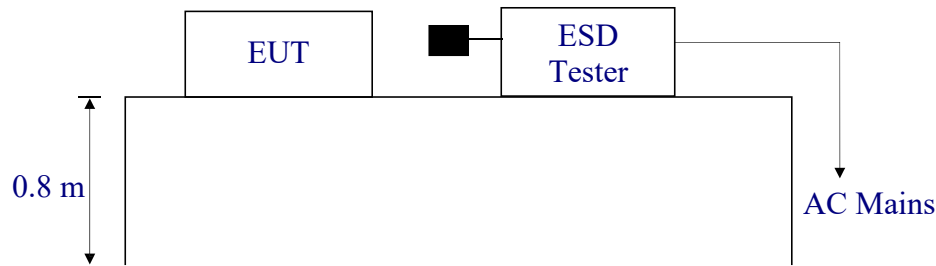

7.2. Test Standard

EN IEC 55014-2:2021, EN 61000-4-2:2009

Severity Level: 3 / Air Discharge:±8KV

Level: 2 / Contact Discharge:±4KV

7.3. Severity Levels and Performance Criterion

7.3.1. Severity level

Level	Test Voltage Contact Discharge (KV)	Test Voltage Air Discharge (KV)
1.	±2	±2
2.	±4	±4
3.	±6	±8
4.	±8	±15
X	Special	Special

7.3.2. Performance criterion : B

A. The apparatus shall continue to operate as intended during and after the test. No degradation of performance or loss of function is allowed below a performance level specified by the manufacturer, when the apparatus is used as intended.

B. The apparatus shall continue to operate as intended after the test. No degradation of performance or loss of function is allowed below a performance level specified by the manufacturer, when the apparatus is used as intended. The performance level may be replaced by a permissible loss of performance. During the test, degradation of performance is however allowed.

C. Temporary loss of function is allowed, provided the function is self-recoverable or can be restored by the operation of the controls.

7.4. EUT Configuration

The following equipment are installed on Electrostatic Discharge Immunity test to meet EN IEC 55014-2:2021, EN 61000-4-2:2009, requirement and operating in a manner which tends to maximize its emission characteristics in a normal application. The configuration of EUT is the same as used in conducted emission test.

Please refer to Section 2.4.

7.5. Operating Condition of EUT

Same as conducted emission measurement, which is listed in Section 3.5 except the test setup replaced by Section 7.1.2.

7.6. Test Procedure

7.6.1. Air Discharge:

This test is done on a non-conductive surface. The round discharge tip of the discharge electrode shall be approached as fast as possible to touch the EUT. After each discharge, the discharge electrode shall be removed from the EUT. The generator is then re-triggered for a new single discharge and repeated 10 times for each pre-selected test point. This procedure shall be repeated until all the air discharge completed.

7.6.2. Contact Discharge:

All the procedure shall be same as Section 7.6.1. Except that the tip of the discharge electrode shall touch the EUT before the discharge switch is operated.

7.6.3. Indirect discharge for horizontal coupling plane

At least 10 single discharges (in the most sensitive polarity) shall be applied at the front edge of each HCP opposite the center point of each unit (if applicable) of the EUT and 0.1m from the front of the EUT. The long axis of the discharge electrode shall be in the plane of the HCP and perpendicular to its front edge during the discharge.

7.6.4. Indirect discharge for vertical coupling plane

At least 10 single discharges (in the most sensitive polarity) shall be applied to the center of one vertical edge of the coupling plane. The coupling plane, of dimensions 0.5m X 0.5m, is placed parallel to, and positioned at a distance of 0.1m from the EUT. Discharges shall be applied to the coupling plane, with this plane in sufficient different positions that the four faces of the EUT are complete illuminated.

7.7. Test Results

PASS

ESD Test Data			
Temperature:	24.5 °C	Relative Humidity:	54%
Pressure:	1009hPa	Test Mode:	Working
Test Voltage:	DC 24V From Adapter Input AC 230V/50Hz	Test Result:	<input checked="" type="checkbox"/> Pass <input type="checkbox"/> Fail
Air Discharge: ± 8KV Contact Discharge: ± 4KV # For each point positive 25 times and negative 25 times discharge			
Test Points	Air Discharge	Contact Discharge	Performance Criterion
Enclosure	N/A	±2,4 KV	B
Button	±2,4,8KV	N/A	B
Metal Part	N/A	±2,4 KV	B
VCP	N/A	±2,4 KV	B
HCP	N/A	±2,4 KV	B
Note: N/A			

8. RF FIELD STRENGTH SUSCEPTIBILITY TEST

8.1. Block Diagram of Test Setup

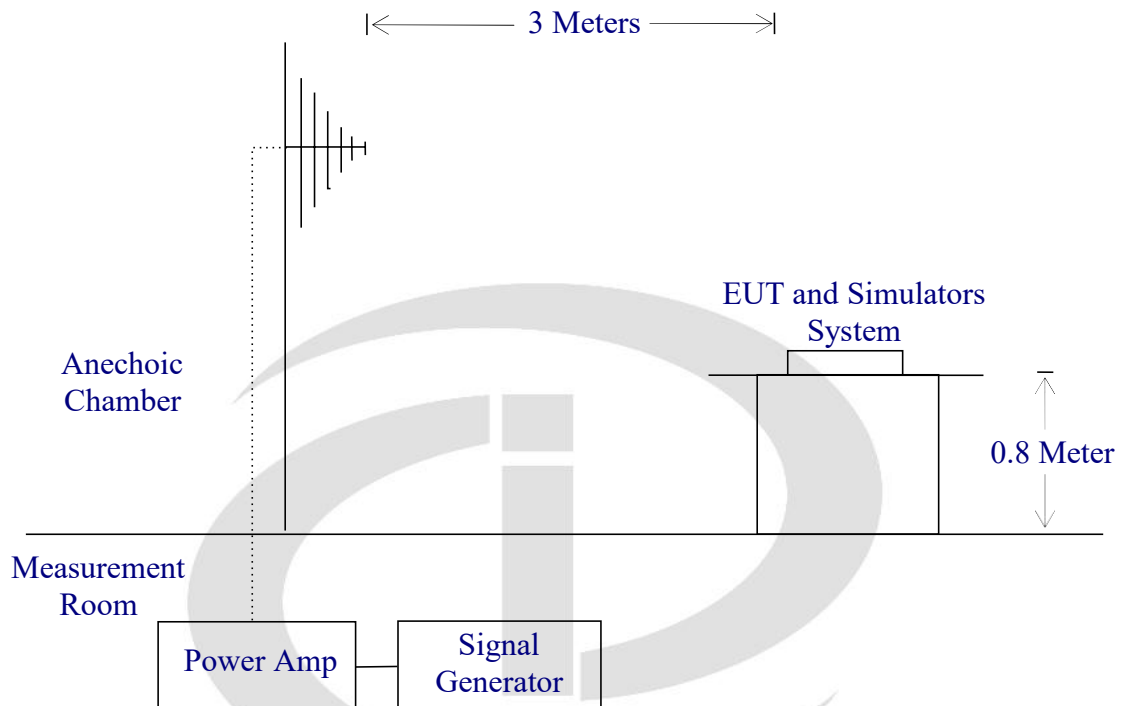

8.2. Test Standard

EN IEC 55014-2:2021, EN IEC 61000-4-3:2020

Severity Level 2, 3V / m

8.3. Severity Levels and Performance Criterion

8.3.1. Severity level

Level	Field Strength V/m
1.	1
2.	3
3.	10
X.	Special

8.3.2. Performance criterion: A

A. The apparatus shall continue to operate as intended during and after the test. No degradation of performance or loss of function is allowed below a performance level specified by the manufacturer, when the apparatus is used as intended.

B. The apparatus shall continue to operate as intended after the test. No degradation of performance or loss of function is allowed below a performance level specified by the manufacturer, when the apparatus is used as intended. The performance level may be replaced by a permissible loss of performance. During the test, degradation of performance is however allowed.

C. Temporary loss of function is allowed, provided the function is self-recoverable or can be restored by the operation of the controls.

8.4. EUT Configuration on Test

The following equipment are installed on Electrical Fast Transient/Burst Immunity test to meet EN IEC 55014-2:2021, EN IEC 61000-4-3:2020, requirement and operating in a manner which tends to maximize its emission characteristics in a normal application. The configuration of EUT is the same as used in conducted emission test.

Please refer to Section 3.4.

8.5. Operating Condition of EUT

Same as conducted emission measurement, which is listed in Section 2.5 except the test setup replaced by Section 8.1.

8.6. Test Procedure

The EUT and its simulators are placed on a turn table which is 0.8 meter above ground. EUT is set 3 meter away from the transmitting antenna which is mounted on an antenna tower. Both horizontal and vertical polarization of the antenna are set on test. Each of the four sides of EUT must be faced this transmitting antenna and measured individually.

All the scanning conditions are as follows :

Condition of Test	Remarks
1. Fielded Strength	3 V/m (Severity Level 2)
2. Radiated Signal	Modulated
3. Scanning Frequency	80 – 1000 MHz
4. Dwell time of radiated	0.0015 decade/s
5. Waiting Time	1 Sec.

8.7. Test Results

PASS

R/S Test Data			
Temperature:	25 °C	Relative Humidity:	53%
Field Strength:	3 V/m	Test Mode:	Working
Test Voltage:	DC 24V From Adapter Input AC 230V/50Hz	Frequency Range:	80 MHz to 1000 MHz
Modulation:	<input checked="" type="checkbox"/> AM <input type="checkbox"/> Pulse <input type="checkbox"/> none 1 KHz 80%		
Steps	1%		
	Horizontal	Vertical	Result
Front	A	A	Pass
Right	A	A	Pass
Rear	A	A	Pass
Left	A	A	Pass
Note: N/A			

中鉴检测
CCTI TESTING

9. ELECTRICAL FAST TRANSIENT/BURST IMMUNITY TEST

9.1. Block Diagram of EUT Test Setup



9.2. Test Standard

EN IEC 55014-2:2021, EN 61000-4-4:2012

9.3. Severity Levels and Performance Criterion

Severity Level 2 at 1KV, Pulse Rise time & Duration: 5 nS / 50 nS

Severity Level:

Open Circuit Output Test Voltage $\pm 10\%$		
Level	On power ports	On I/O(Input/Output) Signal data and control ports
1.	0.5KV	0.25KV
2.	1KV	0.5KV
3.	2KV	1KV
4.	4KV	2KV
X.	Special	Special

Performance criterion: B

A. The apparatus shall continue to operate as intended during and after the test. No degradation of performance or loss of function is allowed below a performance level specified by the manufacturer, when the apparatus is used as intended.

B. The apparatus shall continue to operate as intended after the test. No degradation of performance or loss of function is allowed below a performance level specified by the manufacturer, when the apparatus is used as intended. The performance level may be replaced by a permissible loss of performance. During the test, degradation of performance is however allowed.

C. Temporary loss of function is allowed, provided the function is self-recoverable or can be restored by the operation of the controls.

9.4. EUT Configuration on Test

The following equipment are installed on Electrical Fast Transient/Burst Immunity test to meet EN IEC 55014-2:2021, EN 61000-4-4:2012, requirement and operating in a manner which tends to maximize its emission characteristics in a normal application. The configuration of EUT is the same as used in conducted emission test.

Please refer to Section 3.4.

9.5. Operating Condition of EUT

Same as conducted emission measurement, which is listed in Section 2.6 except the test setup replaced by Section 9.1.

9.6. Test Procedure

EUT shall be placed 0.8m high above the ground reference plane which is a min.1m*1m metallic sheet with 0.65mm minimum thickness. This reference ground plane shall project beyond the EUT by at least 0.1m on all sides and the minimum distance between EUT and all other conductive structure, except the ground plane beneath the EUT, shall be more than 0.5m

9.6.1. For input and output AC power ports:

The EUT is connected to the power mains by using a coupling device which couples the EFT interference signal to AC power lines. Both polarities of the test voltage should be applied during compliance test and the duration of the test is 2 minutes.

9.7. Test Results

The EUT is powered by the DC only, the test item is not applicable.

10. SURGE TEST

10.1. Block Diagram of EUT Test Setup



10.2. Test Standard

EN IEC 55014-2:2021

EN 61000-4-5:2014+A1:2017

10.3. Severity Levels and Performance Criterion

Severity Level: Line to Line, Level 2 at 1KV;

Severity Level: Line to Earth, Level 3 at 2KV.

Severity Level	Open-Circuit Test Voltage (KV)
1.	0.5
2.	1.0
3.	2.0
4.	4.0
X.	Special

Performance criterion: B

A. The apparatus shall continue to operate as intended during and after the test. No degradation of performance or loss of function is allowed below a performance level specified by the manufacturer, when the apparatus is used as intended.

B. The apparatus shall continue to operate as intended after the test. No degradation of performance or loss of function is allowed below a performance level specified by the manufacturer, when the apparatus is used as intended. The performance level may be replaced by a permissible loss of performance. During the test, degradation of performance is however allowed.

C. Temporary loss of function is allowed, provided the function is self-recoverable or can be restored by the operation of the controls.

10.4. EUT Configuration on Test

The following equipment are installed on Electrical Fast Transient/Burst Immunity test to meet EN IEC 55014-2:2021, EN 61000-4-5:2014+A1:2017, requirement and operating in a manner which tends to maximize its emission characteristics in a normal application.

The configuration of EUT is the same as used in conducted emission test. Please refer to Section 3.4.

10.5. Operating Condition of EUT

Same as conducted emission measurement, which is listed in Section 2.7 except the test setup replaced by Section 10.1.

10.6. Test Procedure

- (1) Set up the EUT and test generator as shown on section 10.1
- (2) For line to line coupling mode, provide a 1KV 1.2/50us voltage surge (at open-circuit condition) and 8/20us current surge to EUT selected points.
- (3) At least 5 positive and 5 negative (polarity) tests with a maximum 1/min repetition rate are conducted during test.
- (4) Different phase angles are done individually.
- (5) Repeat procedure 2) to 4) except the open-circuit test voltage change from 1KV to 2KV for line to earth coupling mode test.
- (6) Record the EUT operating situation during compliance test and decide the EUT immunity criterion for above each test.

10.7. Test Result

The EUT is powered by the DC only, the test item is not applicable.

11. INJECTED CURRENTS SUSCEPTIBILITY TEST

11.1. Block Diagram of EUT Test Setup

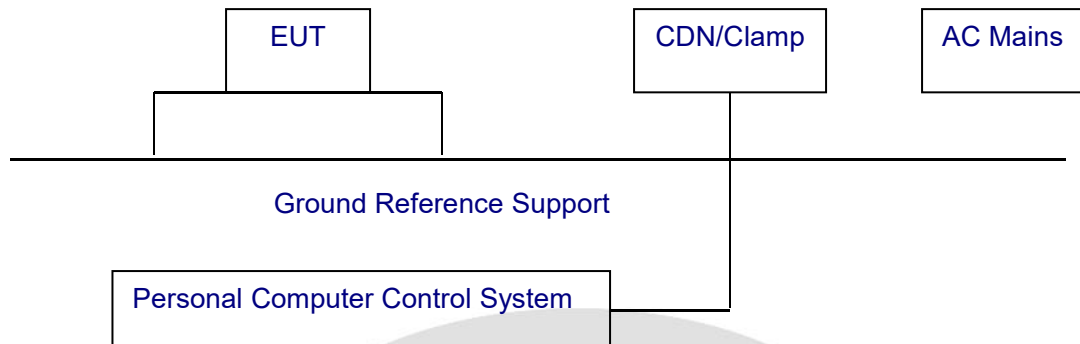

11.2. Test Standard

EN IEC 55014-2:2021, EN 61000-4-6:2014/AC:2015

11.3. Severity Levels and Performance Criterion

Severity Level 2: 3V(rms), 150KHz ~ 80MHz

Severity Level:

Level	Field Strength V
1.	1
2.	3
3.	10
X.	Special

Performance criterion: A

A. The apparatus shall continue to operate as intended during and after the test. No degradation of performance or loss of function is allowed below a performance level specified by the manufacturer, when the apparatus is used as intended.

B. The apparatus shall continue to operate as intended after the test. No degradation of performance or loss of function is allowed below a performance level specified by the manufacturer, when the apparatus is used as intended. The performance level may be replaced by a permissible loss of performance. During the test, degradation of performance is however allowed.

C. Temporary loss of function is allowed, provided the function is self-recoverable or can be restored by the operation of the controls.

11.4. EUT Configuration on Test

The configuration of EUT is the same as used in conducted emission test. Please refer to Section 2.8.

11.5. Operating Condition of EUT

Same as conducted emission test, which is listed in Section 2.8 except the test set up replaced as Section 11.1.

11.6. Test Procedure

- (1) Set up the EUT, CDN and test generator as shown on section 11.1
- (2) Let EUT work in test mode and measure.
- (3) The EUT and supporting equipment are placed on an insulating support 0.1m high above a ground reference plane. CDN (coupling and decoupling device) is placed on the ground plane at above 0.1-0.3m from EUT. Cables between CDN and EUT are as short as possible, and their height above the ground reference plane shall be between 30 and 50 mm (where possible).
- (4) The disturbance signal described below is injected to EUT through CDN.
- (5) The EUT operates within its operational mode(s) under intended climatic conditions after power on.
- (6) The frequency range is swept from 150KHz to 80MHz using 3V signal level, and with the disturbance signal 80% amplitude modulated with a 1KHz sine wave.
- (7) The rate of sweep shall not exceed 1.5×10^{-3} decades/s. Where the frequency is swept incrementally, the step size shall not exceed 1% of the start and thereafter 1% of the preceding frequency value.
- (8) Recording the EUT operating situation during compliance test and decide the EUT immunity criterion for above each test.

11.7. Test Result

The EUT is powered by the DC only, the test item is not applicable.

12. MAGNETIC FIELD IMMUNITY TEST

12.1. Block Diagram of Test Setup



12.2. Test Standard

EN IEC 55014-2:2021, EN 61000-4-8:2010

Severity Level 1 at 1A/m

12.3. Severity Levels and Performance Criterion

12.3.1. Severity level

Input and Output AC Power Ports.

- Voltage Dips.
- Voltage Interruptions.

Environmental Phenomena	Test Specification	Units	Performance Criterion
Voltage Dips	70	% Reduction period	C
	25		
	40	% Reduction period	C
	10		
Voltage Interruptions	0 0.5	% Reduction period	C

12.3.2. Performance criterion: B

A. The apparatus shall continue to operate as intended during and after the test. No degradation of performance or loss of function is allowed below a performance level specified by the manufacturer, when the apparatus is used as intended.

B. The apparatus shall continue to operate as intended after the test. No degradation of performance or loss of function is allowed below a performance level specified by the manufacturer, when the apparatus is used as intended. The performance level may be replaced by a permissible loss of performance. During the test, degradation of performance is however allowed.

C. Temporary loss of function is allowed, provided the function is self-recoverable or can be restored by the operation of the controls.

12.4. EUT Configuration on Test

The configuration of EUT is listed in Section 2.9.

12.5. Operating Condition of EUT

Same as conducted emission test, which is listed in Section 2.9 except the test set up replaced as Section 12.1.

12.6. Test Procedure

The EUT shall be subjected to the test magnetic field by using the induction coil of standard dimensions (1m*1m) and shown in Section 10.1. The induction coil shall then be rotated by 90° in order to expose the EUT to the test field with different orientations.

12.7. Test Results

PASS

MS Test Data					
Temperature:	24.5°C		Humidity:	53%	
Power Supply:	DC 24V From Adapter Input AC 230V/50Hz		Test Mode:	Working	
Environmental Phenomena	Test specification	Units	Coil Orientation	Performance Criterion	Result
Magnetic Field	1	A/m	X	A	PASS
			Y	A	PASS
			Z	A	PASS
Note: N/A					

13. VOLTAGE DIPS AND INTERRUPTIONS TEST

13.1. Block Diagram of EUT Test Setup



13.2. Test Standard

EN IEC 55014-2:2021

EN IEC 61000-4-11:2020/AC:2020-06

13.3. Severity Levels and Performance Criterion

Severity Level:

Input and Output AC Power Ports.

Voltage Dips.

Voltage Interruptions.

Environmental Phenomena	Test Specification	Units	Performance Criterion
Voltage Dips	>95 0.5	% Reduction period	B
	30 25	% Reduction period	C
Voltage Interruptions	>95 250	% Reduction period	C

Performance criterion: B, C, C

A. The apparatus shall continue to operate as intended during and after the test. No degradation of performance or loss of function is allowed below a performance level specified by the manufacturer, when the apparatus is used as intended.

B. The apparatus shall continue to operate as intended after the test. No degradation of performance or loss of function is allowed below a performance level specified by the manufacturer, when the apparatus is used as intended. The performance level may be replaced by a permissible loss of performance. During the test, degradation of performance is however allowed.

C. Temporary loss of function is allowed, provided the function is self-recoverable or can be restored by the operation of the controls.

13.4. EUT Configuration on Test

The configuration of EUT is the same as used in conducted emission test. Please refer to Section 2.10.

13.5. Operating Condition of EUT

Same as conducted emission test, which is listed in Section 2.10 except the test set up replaced as Section 13.1.

13.6. Test Procedure

- (1) Set up the EUT and test generator as shown on section 13.1.
- (2) The interruption is introduced at selected phase angles with specified duration. There is a 3mins minimum interval between each test event.
- (3) After each test a full functional check is performed before the next test.
- (4) Repeat procedures 2 & 3 for voltage dips, only the level and duration is changed.
- (5) Record any degradation of performance.

13.7. Test Result

The EUT is powered by the DC only, the test item is not applicable.

APPENDIX I -- EUT PHOTOGRAPHS



EUT Photo 1

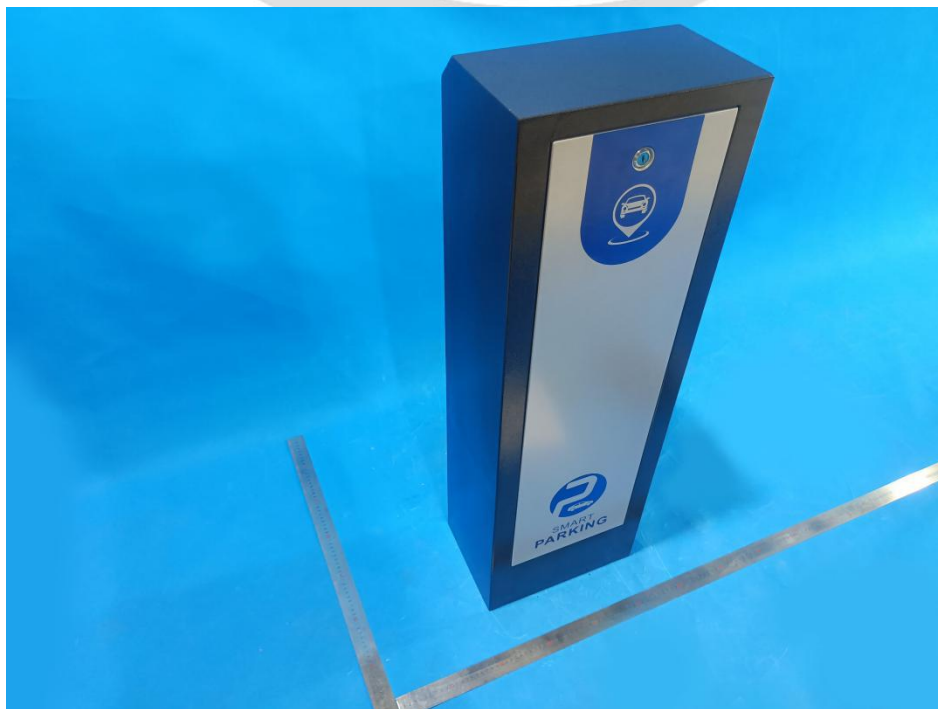

EUT Photo 2



EUT Photo 3

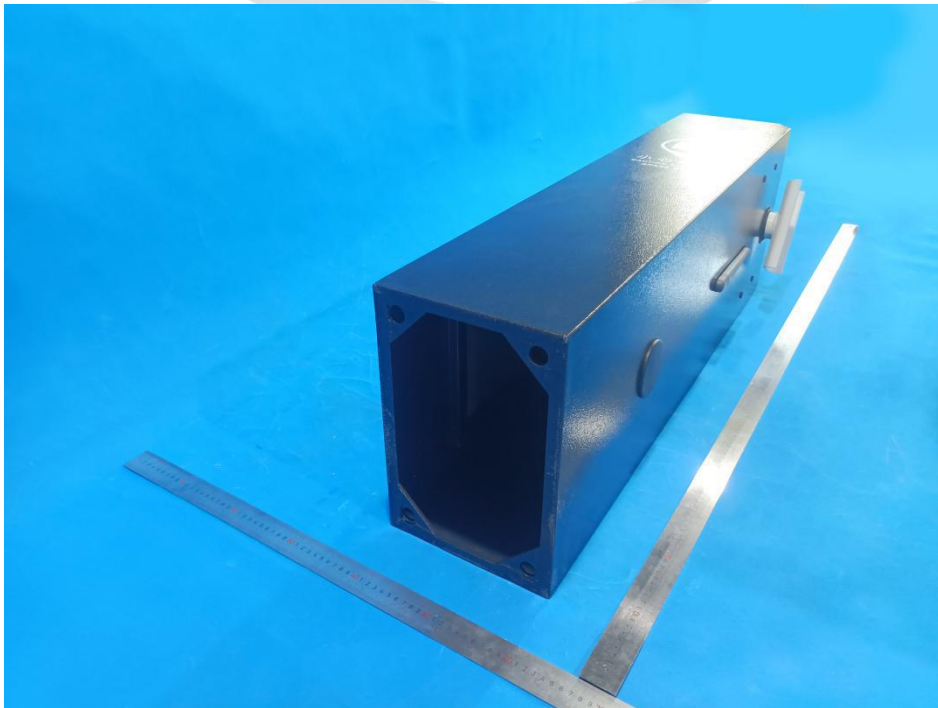

EUT Photo 4

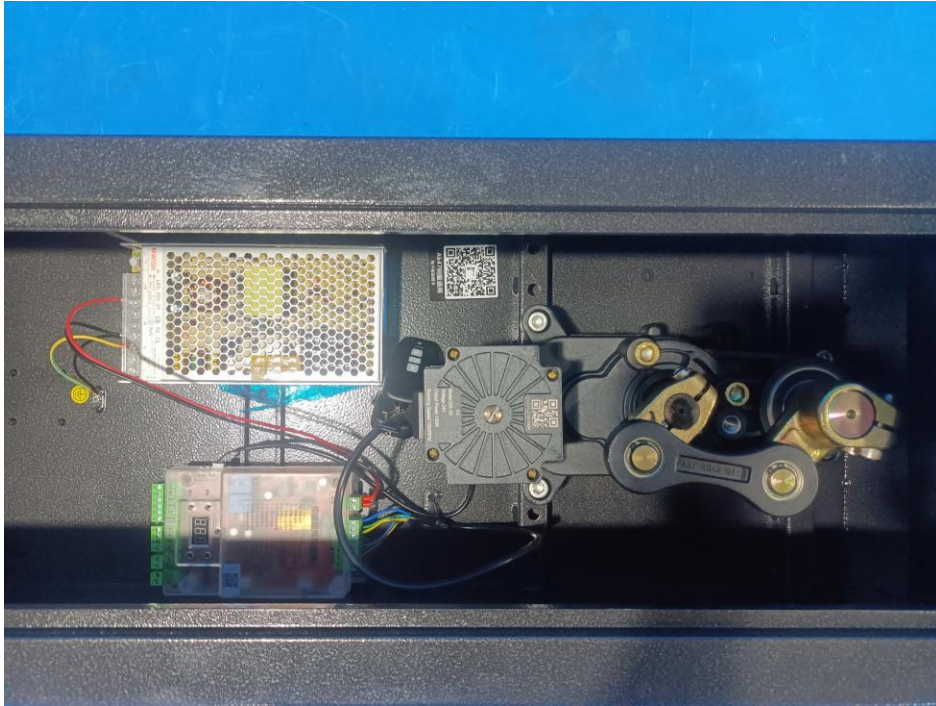

EUT Photo 5



EUT Photo 6

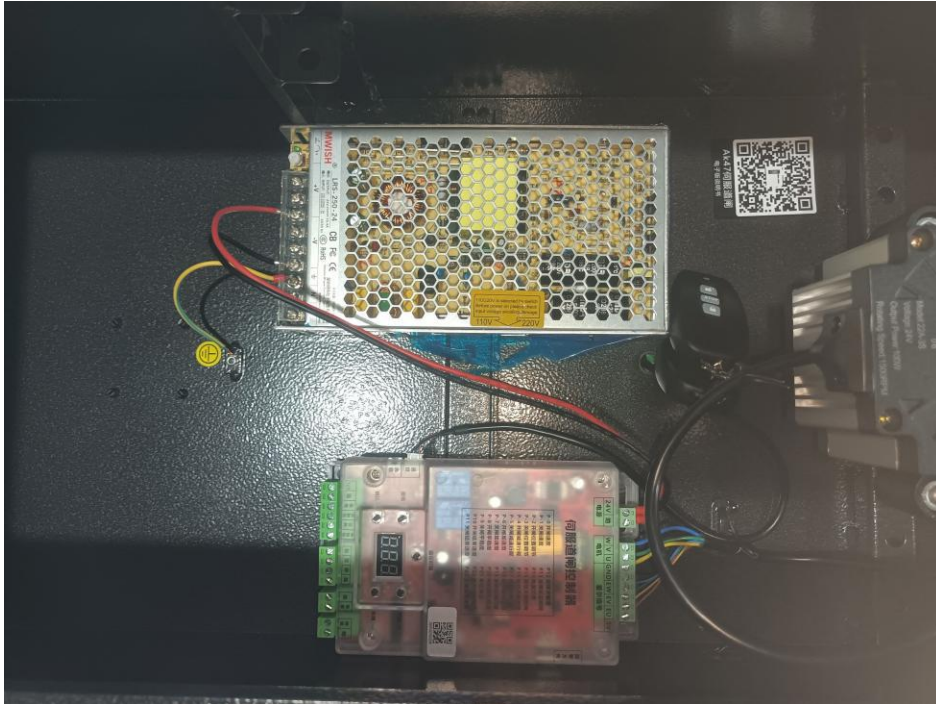

EUT Photo 7

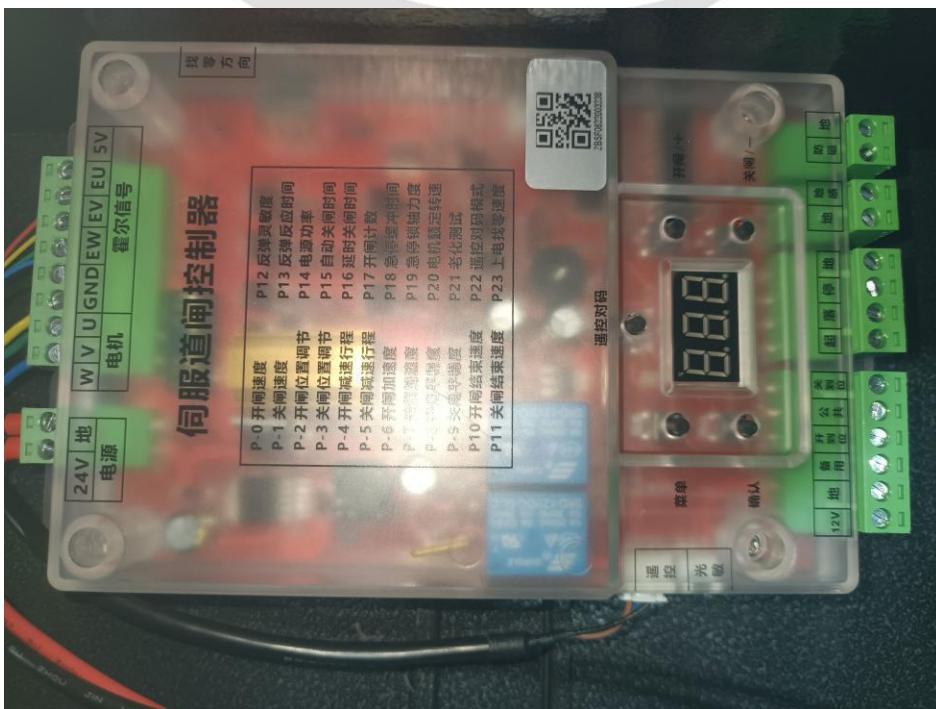

EUT Photo 8

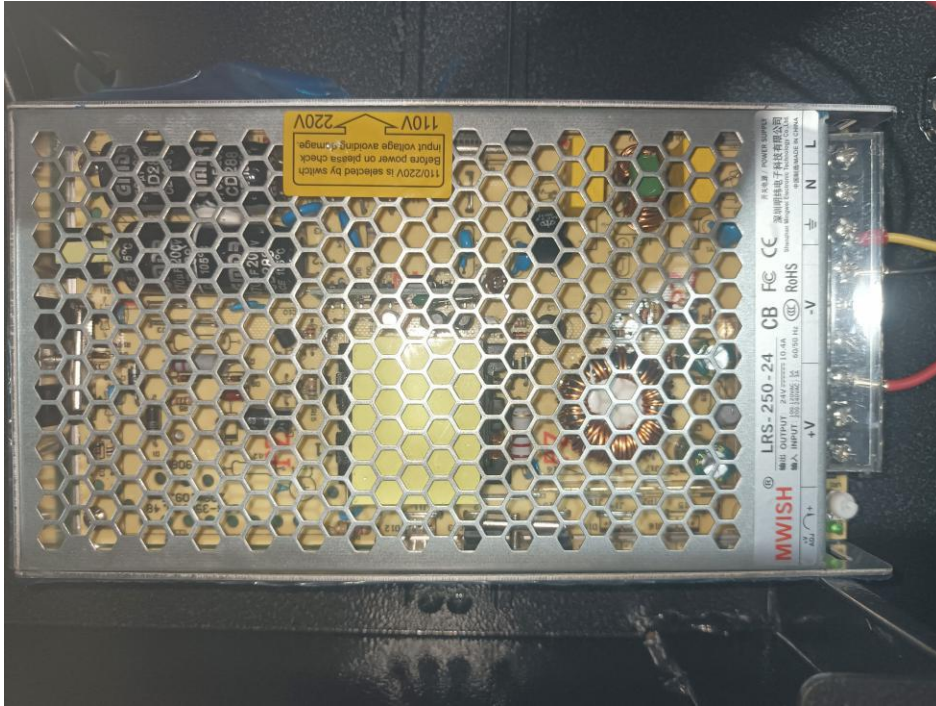

EUT Photo 9

中鉴检测
CCTI TESTING

APPENDIX II -- EUT TEST PHOTOGRAPHS



EUT Photo CE



EUT Photo Clamp

***** END OF REPORT *****